

- CYLINDRICAL V-CHIP CONSTRUCTION FOR SURFACE MOUNTING
  - EXTENDED LOAD LIFE (3,000 ~ 5,000 HOURS)
  - AVAILABLE WITH WIDE TERMINATION & ANTI-VIBRATION SKIRT
  - ULTRA LOW ESR, HIGH RIPPLE CURRENT
  - CAPACITANCE VALUES UP TO 1000 $\mu$ F
  - 6.3x6.3mm ~ 10x10.8mm CASE SIZES
  - REFLOW SOLDERING RATED TO +260°C (see reflow specifications)
  - MEETS THE REQUIREMENTS OF AEC-Q200\*
- \*Contact NIC for supporting test data

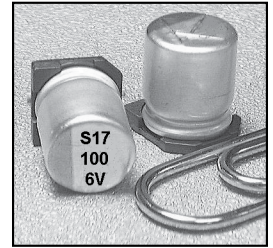

**RoHS Compliant**  
includes all homogeneous materials

\*See Part Number System for Details

### CHARACTERISTICS

Rated Voltage Range	6.3 ~ 16Vdc			
Rated Capacitance Range	10 ~ 1000 $\mu$ F			
Operating Temp. Range	-55 ~ +105°C			
Capacitance Tolerance	$\pm$ 20% (M)			
Max. Leakage Current After 2 Minutes @ 20°C	See Specifications Tables			
Working and Surge Voltage Ratings	W.V. (Vdc)	6.3	10	16
	S.V. (Vdc)	8.2	13	20
Tan $\delta$ @ 120Hz/20°C		0.18	0.16	0.14
Impedance Ratio	Z -55°C/Z +20°C	1 ~ 2.5		
	Z +105°C/Z +20°C	0.6 ~ 1.0		
Load Life Test @ 105°C 6.3mm Dia. = 3,000 Hours 8mm ~ 10mm Dia. parts = 5,000 Hours	Capacitance Change	Within $\pm$ 30% of initial measured value		
	Tan $\delta$ and ESR	Less than 200% of specified max. value		
	Leakage Current	Less than specified max. value		

### PART NUMBER SYSTEM

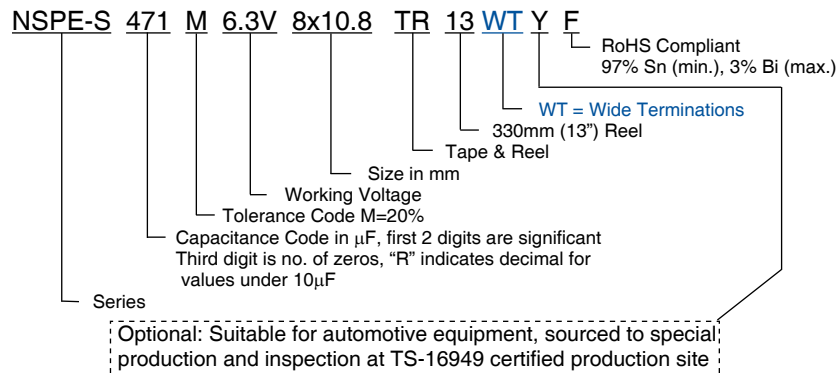

### STANDARD PRODUCTS AND CASE SIZES D $\phi$ x L (mm)

PART NUMBER	Cap. ( $\mu$ F)	Working Voltage	Case Size (D X L) mm	Max. Leakage Current ( $\mu$ A) After 2 minutes*	Max. ESR (m $\Omega$ ) AT 100kHz/20°C	Max. Ripple Current (mA rms) AT 100kHz/105°C
NSPE-S101M6.3V6.3X6.3TR13F	100	6.3	6.3X6.3	126	36	1630
NSPE-S151M6.3V6.3X6.3TR13F	150		6.3X6.3	189	36	1630
NSPE-S221M6.3V6.3X8TR13F	220		6.3X8	278	32	2020
NSPE-S221M6.3V8X10.8TR13F			8X10.8	278	16	3150
NSPE-S331M6.3V8X10.8TR13F	330		8X10.8	416	16	3150
NSPE-S391M6.3V8X10.8TR13F	390		8X10.8	492	16	3150
NSPE-S471M6.3V8X10.8TR13F	470		8X10.8	593	16	3150
NSPE-S561M6.3V8X10.8TR13F	560		8X10.8	706	16	3150
NSPE-S681M6.3V10X10.8TR13F	680		10X10.8	857	15	3890
NSPE-S821M6.3V10X10.8TR13F	820		10X10.8	1034	15	3890
NSPE-S102M6.3V10X10.8TR13F	1000		10X10.8	1260	15	3890

For Automotive Applications See Part Numbering System

\*Please review typical leakage current performance, as shown on NIC load life endurance test report.



### STANDARD PRODUCTS AND CASE SIZES D $\phi$ x L (mm)

PART NUMBER	Cap. ( $\mu$ F)	Working Voltage	Case Size (D X L) mm	Max. Leakage Current ( $\mu$ A) After 2 minutes*	Max. ESR (m $\Omega$ ) AT 100kHz/20°C	Max. Ripple Current (mA rms) AT 100kHz/105°C
NSPE-S330M10V6.3X6.3TR13F	33	10	6.3X6.3	100	40	1510
NSPE-S470M10V6.3X6.3TR13F	47		6.3X6.3	100	40	1510
NSPE-S680M10V6.3X6.3TR13F	68		6.3X6.3	136	40	1510
NSPE-S101M10V6.3X8TR13F	100		6.3X8	200	35	1910
NSPE-S101M10V8X10.8TR13F			8X10.8	200	18	2800
<b>NSPE-S151M10V6.3X8TR13F</b>	150		<b>6.3X8</b>	<b>300</b>	<b>35</b>	<b>1910</b>
NSPE-S151M10V8X10.8TR13F			8X10.8	300	18	2800
NSPE-S221M10V8X10.8TR13F	220		8X10.8	440	18	2800
NSPE-S331M10V8X10.8TR13F	330		8X10.8	660	18	2800
NSPE-S471M10V10X10.8TR13F	470		10X10.8	940	16	3650
NSPE-S561M10V10X10.8TR13F	560		10X10.8	1120	16	3650
NSPE-S100M16V6.3X6.3TR13F	10		16	6.3X6.3	100	54
NSPE-S220M16V6.3X6.3TR13F	22	6.3X6.3		100	54	1130
NSPE-S330M16V6.3X6.3TR13F	33	6.3X6.3		106	54	1130
NSPE-S470M16V6.3X8TR13F	47	6.3X8		151	45	1480
NSPE-S470M16V8X10.8TR13F	47	8X10.8		151	22	2290
NSPE-S680M16V8X10.8TR13F	68	8X10.8		218	22	2290
NSPE-S101M16V8X10.8TR13F	100	8X10.8		320	22	2290
NSPE-S151M16V10X10.8TR13F	150	10X10.8		480	20	2920

For Automotive Applications See Part Numbering System

\*Please review typical leakage current performance, as shown on NIC load life endurance test report.

### RIPPLE CURRENT FREQUENCY CORRECTION FACTORS

Cap. $\mu$ F	100Hz	1KHz	10KHz	100KHz
C $\leq$ 10	0.03	0.20	0.50	1.00
> 10	0.05	0.20	0.50	1.00

### Part Marking

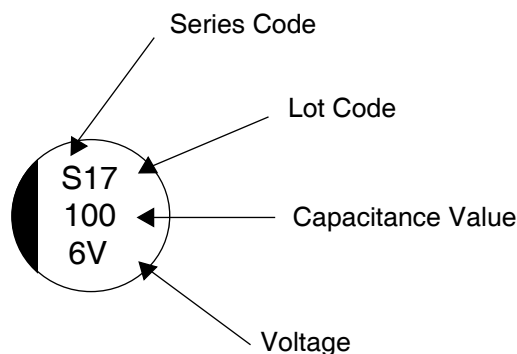

### PRECAUTIONS

Please review the notes on correct use, safety and precautions found on pages T10 & T11 of NIC's **Electrolytic Capacitor catalog**.  
 Also found at [www.niccomp.com/precautions](http://www.niccomp.com/precautions)  
 If in doubt or uncertainty, please review your specific application - process details with NIC's technical support personnel: [tpmg@niccomp.com](mailto:tpmg@niccomp.com)



### DIMENSIONS (mm)

Case Size	Dφ ±0.5	L max.	A, B ±0.2	W	l ±0.2	P ±0.2
6.3x6.3	6.3	6.3	6.6	0.5 ~ 0.8	2.5	2.2
6.3x8	6.3	8.0	6.6	0.5 ~ 0.8	2.5	2.2
8x10.8	8.0	10.8	8.3	0.7 ~ 1.0	2.9	3.2
10x10.8	10	10.8	10.3	1.0 ~ 1.4	3.2	4.6

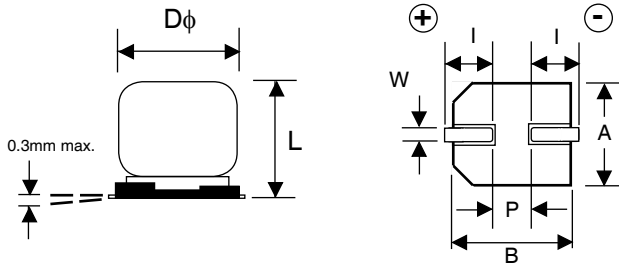

### LAND PATTERN DIM. (mm)

Case Dia.	A	B	P
6.3	3.5	1.8	2.1
8	4.1	2.1	2.8
10	4.4	2.5	4.3

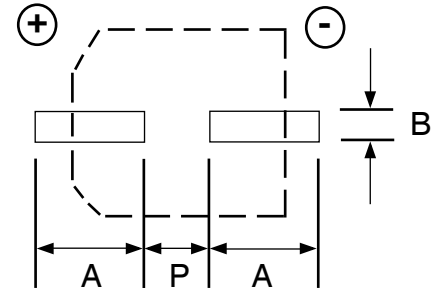

### WIDE TERMINATION DIM. (mm)

Case Size	Dφ ±0.5	L ± 0.5	A, B	C ±0.2	P ±0.2	W	R	T
8 x 10.8WT	8.0	10.5	8.3 ± 0.2	9.0	3.2	0.7 ~ 1.0	(0.7)	(1.3)
10 x 10.8WT	10.0	10.5	10.3 ± 0.2	11.0	4.6	1.0 ~ 1.4	(0.7)	(1.3)

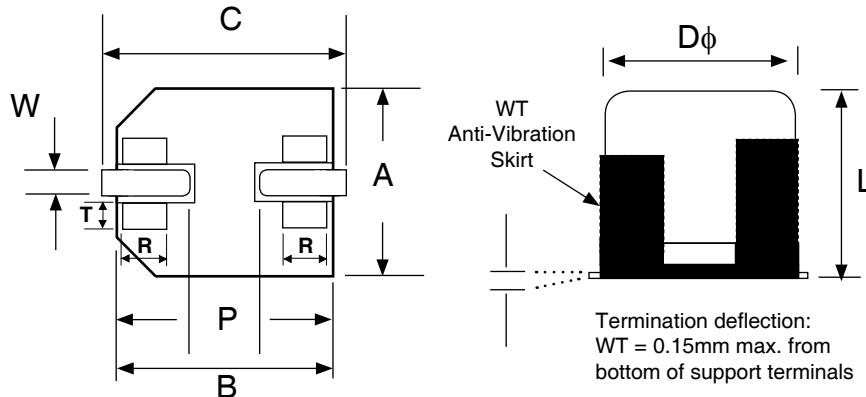

### WIDE TERMINATION LAND PATTERN DIM. (mm)

Case Size	a	b	c
8x10.8	2.5	4.5	4.7
10x10.8	3.8	4.8	4.7

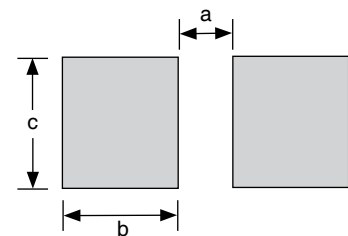

### RECOMMENDED REFLOW SOLDERING PROFILE

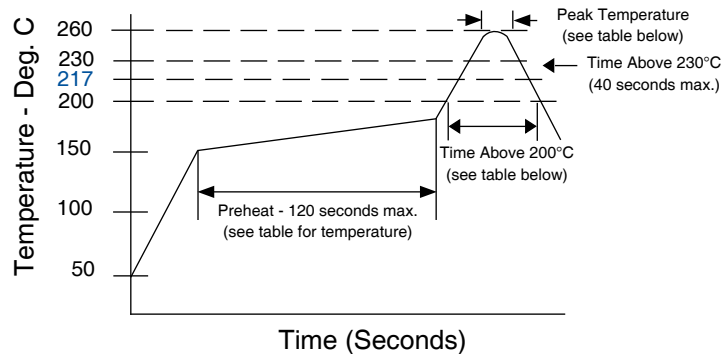

### PEAK TEMPERATURES AND DURATIONS

Diameter	Preheat (120 sec. max.)	Time above 200°C	Time above 217°C	Time above 230°C	Peak Temperature	Number of Reflow Passes
6.3 ~ 10mm	150°C ~ 190°C	100 sec. max.	80 sec. max.	40 sec. max.	250°C/5 sec.	2x*
	150°C ~ 180°C	60 sec. max.	50 sec. max.	40 sec. max.	260°C/instantaneous	1x

\*Two reflow passes are permissible with a cool down to room temperature required between the first and second pass.



## TAPING SPECIFICATIONS (mm)

- Both Leader and Trailer tape: Minimum 40mm (1.57") empty carrier tape pockets.
- Leader tape: Approximately 20cm of cover tape at leader.
- Connection: Maximum 3 connections (slices) per reel.

Case Size	A ±0.5	B ±0.5	C ±0.3	D ±0.1	P ±0.1	T ±0.2	t max.
6.3x6.3	7.0	7.0	16.0	7.5	12.0	6.5	0.4
6.3x8	7.0	7.0	16.0	7.5	12.0	8.2	0.4
8x10.8	8.7	8.7	24.0	11.5	16.0	11.1	0.4
10x10.8	10.7	10.7	24.0	11.5	16.0	11.2	0.4

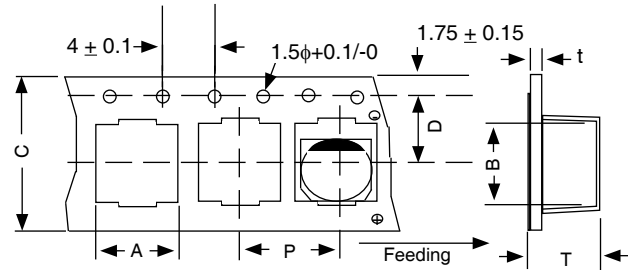

## REEL DIMENSIONS (mm)

Case Size	W ±1.0	Qty per Reel	
		13" (330mm)	15" (380mm)
6.3x6.3	18	800	1,000
6.3x8	18	500	900
8x10.8	26	300	500
10x10.8	26	300	500

